

# Laser Systems for Geometric Alignment L-730/740 Series

Single-Axis/Multi-Axis Lasers for  
Precision Alignment and Analysis



**HAMAR  
LASER**<sup>®</sup>  
ALIGN WITH THE BEST

# Properly Aligned Machinery And Process Lines Run Better, Last Longer

## Why Laser Alignment?

Sooner or later everything goes out of alignment. Machinery and process lines, when properly aligned, run better, last longer, require less maintenance, lower production costs and improve productivity.

Hamar Laser systems offer significant advantages over traditional alignment devices:

- Up to 70% faster
- Simultaneous multi-axis alignment
- Ultra high accuracy and reduced setups
- Data displays automatically update with each adjustment

As the leader in laser alignment technology, we introduced the world's first flat laser plane in 1974, and the first automatically sweeping laser plane in 1985. Today, no one can match our innovative systems for accuracy, versatility, fast setup, ease of use and the immediate, real-time generation of alignment data.

## Hamar's Geometric Alignment Capabilities

### Flatness (Level)

- Tables and Separated Surfaces
- Machine Beds and Lines of Motion
- Machine Bed and Vertical Axis Twist
- Surface Plates
- Pitch and Roll Angular Measurements

### Squareness

- Columns to Tables or Rails
- X to Y Axis, Z to X Axis and Z to Y Axis
- Rotary Axes to Main Machine Axes

### Straightness

- Machine Beds and Lines of Motion
- Column Travel
- Yaw Angular Measurement
- Beams or Other Structures

### Parallelism

- Master Rail to Slave Rails on Gantry
- A, B, C & W Axes to Main Machine Axes
- Roll-to-Roll
- Platen to Platen, Ram to Ram

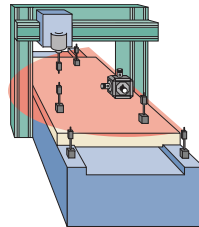

Flatness

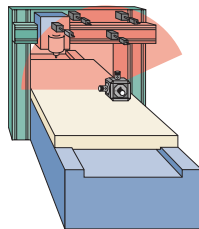

Squareness

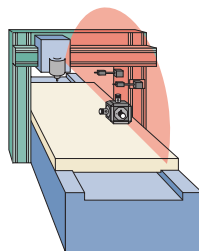

Straightness

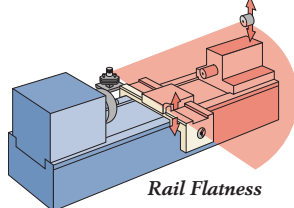

Rail Flatness

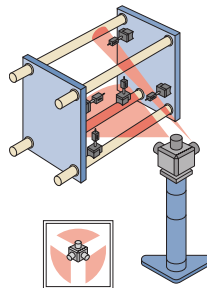

Parallelism and Tie-Bar Squareness

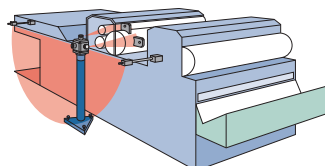

Roll Parallelism

## Case Histories

### 1 Aircraft Assembly

An aerospace company needed a reliable way to keep a large tooling fixture constantly level during production. They evaluated a laser tracker and Hamar's L-740 Leveling Laser. Since the laser tracker only measured one point at a time, it required multiple operators and setups, and took over four hours to measure and adjust all leveling locations. The laser tracker also had to measure each point several times to verify if adjusting one location had caused another to move.

Hamar's L-740, using multiple wireless targets simultaneously feeding data into a laptop computer (and just one operator), was able to level the fixture in 10 minutes! Hamar's system also allowed the leveling process to be fully automated by feeding data into the PLC that was driving the actuators and adjusting the fixture — something that was not possible with a tracker. Hamar's L-740 system did the job 18x faster than the laser tracker, and at 1/3 the cost.

### 2 Adhesive Tape Manufacturing

Here's what a large tape products manufacturer had to say: "We are getting great results from Hamar's (L-742) roll alignment system. We trained four technicians how to use it, and they now travel from plant to plant doing alignments. In 10 months, our ROI is 3x, based on the fees we use to pay to optical alignment sub-contractors. And, that doesn't include all the downtime we've saved. Hamar's system is also more accurate than other alignment methods we've used. Thanks for a top-shelf 'rubber meets the road' solution."

### 3 Aluminum Mill

An ingot-producing machine at an aluminum mill needed aligning, a job normally assigned to an in-house team using an optics-based leveling system. Wanting to do the job faster, the mill decided to evaluate Hamar's L-743 Triplescan™ Laser. Two optics crews worked alongside one Hamar technician using the L-743. The task was to align the central ram in the pit to machine rails running parallel along the edge of the pit 15' away, to a tolerance of .005".

Hamar's laser was able to measure five points for every one the optics crew could measure. The L-743 did the job in 36 hours compared to the normal 72 to 96 hours. Using Hamar's system the mill recovered \$250,000 in lost production, and ingot quality went up dramatically.

# How Lasers Work: Principles of Operation

LASER is an acronym for Light Amplification by Stimulated Emission of Radiation. Lasers radiate in a single wavelength, in one direction and in a straight line, and are detected by position sensing detectors (PSDs). PSDs detect and convert the center of energy of the laser spot into a calibrated digital reading for output to a hand-held readout or computer interface.

Continuously sweeping laser planes are produced by bending a laser beam precisely 90° using an optical pentaprism. Hamar Laser applies a patented correction process to the pentaprisms to produce ultra-flat, continuously sweeping laser planes.

To measure flatness, straightness or squareness, laser planes are used as references and need to be aligned or "bucked in" to reference points, either on a surface or along a machine's axis. Three reference points are needed to make the laser plane parallel to a surface. And, only two points are needed to measure the straightness of an axis or a machine way. The laser plane is bucked in to a surface or line of

motion by adjusting the pitch, roll or yaw of the laser base, tilting the laser plane until the target displays the same reading at each reference point.

The targets are then used to measure the deviation from the reference points up to 100 feet (30.5 meters) away from the laser. The data provided by the targets is automatically — and instantly — updated so the machine can be adjusted and the readout will show the movement. When it shows zero, it's aligned!

Hamar's multi-plane lasers all feature laser planes that are orthogonal to each other and thus can be used to measure the squareness between surfaces or machine axes. In most cases with one setup, the laser can measure the squareness between all the axes of the machine tool. Please visit [www.hamarlaser.com](http://www.hamarlaser.com) under "How Lasers Work" for a more detailed description.



## Comparison Matrix — Geometry Measuring Systems

|   | Feature   | Hamar Laser   | European Geo. Laser Manufacturers                                    | Interferometers (Linear Distance Laser)                            | Laser Trackers   | Traditional Methods (Straight edge, levels, squares, etc.) |  |
|---|---|---|--|--|--|--|--|
| Machining Center Alignment                | Automatically rotating laser planes?              | Yes, 7 Models   | Yes for 2 mfgs., others use "Point & Shoot technology"               | No, laser line only  | No, laser line only  | No   |  |
|   | Can be used for alignment?                        | Yes   | Yes  | No, measurement only   | No, measurement only   | Yes, for some  |  |
|   | No. of setups for machine tools                   | Usually 1-2   | 3-4  | 8+   | 1-3+   | 5+   |  |
|   | No. Auto Rotating Laser Planes                    | 3 with Triple Scan  | 1  | 0  | 0  | n/a  |  |
|   | Estimated time savings (alignment time vs. Hamar) | 0   | 40-50% slower  | 70-80% slower  | 40-50% slower  | 60-70% slower  |  |
|   | Does target data update with alignment?           | Yes   | Yes  | No   | No   | Yes  |  |
|   | Measure multiple machine axes with 1 setup?       | Yes, up to 5  | Yes, up to 2   | No   | Yes  | Yes, up to 2   |  |
|   | Measure multiple machine axes simultaneously?     | Yes, up to 5  | Yes, up to 2   | No   | No   | Yes, up to 2   |  |
|   | Sensors used simultaneously                       | Up to 8 in PDA  | 1  | 1  | 1  | n/a  |  |
|   | Measurement range of targets:                     | Up to 33 mm   | 10-75 mm   | 5-10 mm  | n/a  | n/a  |  |
|   | Wireless data delivery?                           | Yes   | 1, yes, the rest, no   | No   | No   | No   |  |
|   | No. of setups for surface plate                   | 1   | 1  | 6+ setups  | n/a  | 8+ setups  |  |
|   | Accurate for machine tools?                       | Yes   | Straightness: Yes. Flatness, Squareness, Parallelism: No             | Yes  | No   | Yes, but depends on instrument                             |  |
|   | Target resolution:                                | up to 0.00025 mm  | up to 0.001 mm   | up to 0.0001 mm  | up to 0.0001 mm  | typically 0.01 mm  |  |
| Measure entire length of machine axis?    | Yes   | Yes, but very slowly and not to machine tool specs            | Yes  | Yes, but not to machine tool specs                                 | No   |  |  |
| Measure parallelism of gantry mill rails? | Yes   | Yes, but very slowly and not to machine tool specs            | No   | Yes, but not to machine tool specs                                 | Yes, if rails are <1 M apart   |  |  |
| Measure bed twist?                        | Yes   | Yes, but very slowly and not to machine tool specs            | No   | Yes, but not to machine tool specs                                 | Yes, with difficulty & low accuracy                                      |  |  |
| Cost factor index                         | 1.0   | 0.8   | 1.8  | 5.0  | 0.3  |  |  |
|   | Feature   | Hamar Laser   | Company A  | Company B  | Company C  | Interferometers (Linear Distance Laser)                    | Laser Trackers                             |
| Other Differences                         | Accuracy of laser plane:                          | 0.0025 mm/M for plane 0.001 mm/M for line                     | Not specified  | 0.03 mm/M  | Approx. 0.02 mm/M  | N/A (Laser line only)                                      | Not readily available                      |
|   | Step error in laser plane:                        | +/- 0.0025 mm   | Not specified  | +/- 0.05 mm  | Not specified  | n/a  | n/a  |
|   | Squareness measurement capability                 | up to 0.005 mm/M  | Approx. 0.01 mm/M laser to beam                                      | 0.03 mm/M laser to beam  | Cannot measure squareness  | Not specified  | Not specified                              |
|   | Range of laser:                                   | 30.5 meters in radius   | 40 meters in radius  | 20 meters in radius  | 60 meters in radius  | 40 meters total  | 40 meters total                            |
|   | Display equipment for target data:                | Wireless PDA or PC interface – up to 8 targets simultaneously | Wired display box – can download data into PC – one target at a time | Wired/Wireless Display box - must transfer data to PC for analysis | Proprietary display box can download data into PC – one target at a time | Laptop only – no handheld device                           | Desktop computer only – no handheld device |
|   | Offer machine alignment software?                 | Yes, 3D Plot runs on Windows PC                               | no   | no   | no   | Yes, for linear compensation                               | No   |
|   | Offer surface measurement software?               | Yes, Plane5 runs on Windows PC                                | Yes, runs on display box   | Yes, runs on display box   | Yes, runs on display box   | Yes, one axis at a time                                    | Yes, 3D measurement                        |
|   | Offer deflection monitoring software?             | Yes, Read8 runs on Windows PC                                 | No   | No   | No   | Not possible with interferometer                           | Yes, but not automatically                 |
|   | Measure roll for each machine axis?               | Yes very easily   | Possible but difficult & very time consuming                         | Possible but difficult & very time consuming                       | Possible but difficult & very time consuming                             | No   | No   |
|   | Measure roll of machine's vertical axis?          | Yes very easily   | Possible but difficult & very time consuming                         | Possible but difficult & very time consuming                       | Possible but difficult & very time consuming                             | No   | No   |
| Roll alignment:                           | Yes   | Yes, but very time consuming & low accuracy                   | Yes, but very time consuming & low accuracy                          | No   | No   | Yes, with difficulty & low accuracy                        |  |

# L-730 Series Systems

## Laser System Options

Different applications require different levels of accuracy which is why we developed two basic families of laser alignment systems:

**L-730 Series.** Ideal for precision-level work but where tolerances are not as critical (e.g. simple fabrication alignment checks, etc.)

**L-740 Series.** Ultra-precise, used for more demanding "mission critical" tasks (e.g. aligning complex machine tool geometry, etc.)

Each family of lasers is available in single, dual and triple-plane versions. Many of the features and accessories within the two families are the same. The key difference is the degree of accuracy. For example, with the L-730 Series, laser plane flatness is accurate to 2 arc seconds (.00012"/ft or 0.01 mm/M). With the L-740 Series it's a more stringent 0.5 arcsec (.00003"/ft or 0.0025 mm/M).

As would be expected, the tighter the tolerances and greater the accuracy level, the higher the price. Accordingly, the L-730 Series is an economical choice perfectly suitable for a wide range of alignment applications that do not require the ultra-precision attainable in our L-740 Series lasers.

## L-730 & L-740 Series Features

- Live data output to measure — then fix — misalignment, in real time.
- Continuously sweeping laser planes with a range of 100' (30.5 m) in radius.
- Built-in squareness measuring capability of up to .00006"/ft or 0.005 mm/M (multi-plane lasers only).
- Multiple targets displayed simultaneously for faster alignment and setup.
- Collect flatness and straightness data simultaneously.
- Work up to 70% faster than interferometers, theodolites, transits and other conventional methods.
- Easy to learn how to use, simple to operate.
- Able to collect complete geometry data on most machines in under 90 minutes.

Additional specifications are listed on the back panel, or for more details visit our web-site at: [www.hamarlaser.com](http://www.hamarlaser.com).

## High-Accuracy, Economically-Priced Laser Alignment Systems

### Features and Benefits

The L-730 Series of single, dual and triple-plane laser systems adapts Hamar's metrology innovations to applications with less stringent alignment requirements like fabrication alignment, textile roll alignment, woodworking, and the water-jet/laser-cutting machine tool industries. You get the benefits of our high-accuracy laser systems, at a price that is easier to justify.

### L-730 Series Features:

- One, two or three auto-rotating laser planes
- Laser plane accurate to .00012"/ft or 0.01 mm/M
- Laser plane orthogonality: up to .00012"/ft or 0.01 mm/M
- Built-in, backlit level vials with .00012"/ft or 0.01 mm/M accuracy
- Dimension measuring capability with target height-gage feature
- 3-axis adjustment base for fast setups

In addition, the L-730 Series lasers feature two target options: a) the A-1519-2.4ZB Single-Axis Target with 2.4GHz wireless communication (to PDA or PC), 1.3" x .4" (33x13 mm) PSD sensor, .00002" (0.0005 mm) resolution; and b) the A-1520-2.4ZB Single-Axis Target with 2.4GHz wireless communication (to PDA or PC), .4" x .4" (10x10 mm) PSD sensor, .00001" (0.00025 mm) resolution, both of which automatically download the target data into our S-1387 Machine-Tool Geometry or S-1388 Plane5 Surface Analysis software.

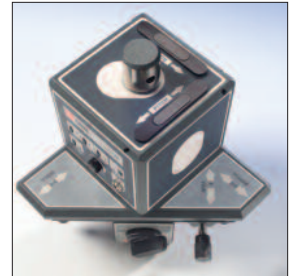

*L-730 Precision Leveling Laser System*



*L-732 Precision Dual Scan® Laser*



*L-733 Precision Triple Scan® Laser*

# L-740 Series Systems



L-740 Ultra-Precision Leveling Laser



L-741 Ultra-Precision Leveling Laser (with Plumb Beam)



L-742 Ultra-Precision Dual Scan Laser



L-743 Ultra-Precision Triple Scan Laser

## Laser Alignment Systems for Complex, Ultra-Precise Applications

### Features and Benefits

Our ultra-precision L-740 Series Laser Alignment Systems represent the pinnacle of achievement in laser alignment technology. With the L-743 Triple Scan® laser, measure flatness, straightness, and squareness simultaneously, with one setup! Powerful machine geometry analysis software automatically downloads alignment data, corrects laser-slope and poor-reference-point errors and produces comprehensive alignment reports.

### L-740 Series Features:

- One, two or three auto-rotating laser planes
- Laser plane flatness: .00003"/ft or 0.0025 mm/M
- Laser plane orthogonality: up to .00006"/ft or 0.005 mm/M
- Built-in, backlit level vials with up to .00006"/ft or 0.005 mm/M accuracy
- 3-axis adjustment base for fast setups

The system comes with 2 wireless target options:

- A-1519-2.4ZB Single-Axis Target with 2.4GHz wireless (to PDA or PC), 33x13 mm PSD, .00002" (0.0005 mm) resolution; and

- A-1520-2.4ZB Single-Axis Target with 2.4GHz wireless (to PDA or PC), 10x10 mm PSD, .00001" (0.00025 mm) resolution,

Both targets automatically download the target data into our S-1387 Machine-Tool Geometry, S-1388 Plane5 Surface Analysis software or R-1355-2.4ZB Rugged PDA wireless readout, which can display up to 8 targets, 4 simultaneously. The A-910-2.4ZB Wireless PC radio receiver can download data from up to 99 targets at the same time.

## Which Laser System Is Right For You?

|                              | Precision Series                          |                         |        | Ultra Precision Series                     |                               |        |          |
|------------------------------|---|-------------------------|--------|--|-------------------------------|--------|----------|
|                              | L-730                                     | L-732                   | L-733  | L-740                                      | L-741                         | L-742  | L-743    |
| # of Laser Planes            | 1   | 2                       | 3      | 1  | 1                             | 2      | 3        |
| Measurement Tasks            |   |                         |        |  |                               |        |          |
| Flatness/Leveling            | •   | •                       | •      | •  | •                             | •      | •        |
| Machine Bed Flatness         | •   | •                       | •      | •  | •                             | •      | •        |
| Squareness                   |   | •                       | •      | •  | •                             | •      | •        |
| Straightness                 | •   | •                       | •      | •  | •                             | •      | •        |
| Parallelism                  | •   | •                       | •      | •  | •                             | •      | •        |
| Rail Parallelism             |   | •                       | •      |  |                               | •      | •        |
| Typical Applications         |   |                         |        |  |                               |        |          |
| Machine Tool Geometry        |   |                         |        | •  | •                             | •      | •        |
| Roll Alignment               |   | •                       | •      |  |                               | •      | •        |
| Inj. Molding Mach.           |   | •                       | •      |  |                               | •      | •        |
| Aerospace Assem.             | •   | •                       | •      | •  | •                             | •      | •        |
| Surface Plates               |   |                         |        | •  | •                             | •      | •        |
| Large-Part Align.            | •   | •                       | •      | •  | •                             | •      | •        |
| Fabrication Alignment/Equip. | •   | •                       | •      |  |                               |        |          |
| Alignment Capabilities       |   |                         |        |  |                               |        |          |
| Laser Plane Flatness         | .00012"/ft or 0.01 mm/M                   |                         |        | .00003"/ft or 0.0025 mm/M                  |                               |        |          |
| Beam Plane Squareness        | n/a                                       | .00012"/ft or 0.01 mm/M |        | n/a  | up to 00006"/ft or 0.005 mm/M |        |          |
| Adjustment Parameters        |   |                         |        |  |                               |        |          |
| Coarse Adjustment Range      | +/- 3.0 degrees                           |                         |        | +/- 3.0 degrees                            |                               |        |          |
| Fine Adjustment Range        | n/a                                       |                         |        | +/- .03 degrees                            |                               |        |          |
| Course Adjustment Resolution | .010" (0.25 mm) in 100 feet (30.5 meters) |                         |        | .010" (0.25 mm) in 100 feet (30.5 meters)  |                               |        |          |
| Fine Adjustment Resolution   | n/a                                       |                         |        | .001" (0.025 mm) in 100 feet (30.5 meters) |                               |        |          |
| Target/Readout Options       |   |                         |        |  |                               |        |          |
| Target:                      |   |                         |        |  |                               |        |          |
| A-1519 & A-1520 Wireless     | std.                                      | std.                    | std.   | std.                                       | std.                          | std.   | std.     |
| Recommended Qty: 1           | 2-3                                       | 3-5                     |        | 1  | 1                             | 2-3    | 3-5      |
| Readout:                     |   |                         |        |  |                               |        |          |
| Single-Axis Displ.           | std.                                      | std.                    | std.   | std.                                       | std.                          | std.   | std.     |
| Wireless                     | opt.                                      | std.                    | std.   | std.                                       | std.                          | std.   | std.     |
| Price Range                  |   |                         |        |  |                               |        |          |
|                              | \$  | \$\$                    | \$\$\$ | \$\$                                       | \$\$                          | \$\$\$ | \$\$\$\$ |

# Powerful Data Analysis Software

Hamar's alignment software, combined with newly-designed wireless interfaces, makes collecting and analyzing alignment data fast and easy. Software is Windows based, and provides large, readable color graphics. Shown below is just a sampling of typical data screens.

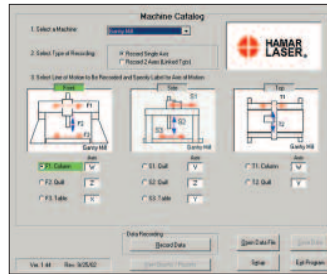

**Machine Tool Geometry — Machine Setup Screen.**  
Choose from multiple machine configurations. Used for machining center calibration.

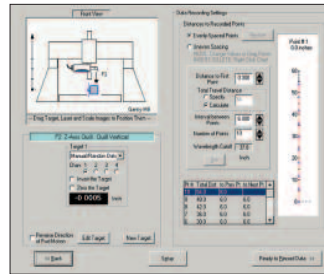

**Machine Tool Geometry — Axis Setup Screen.**  
Set up each line of motion for number of points to be measured.

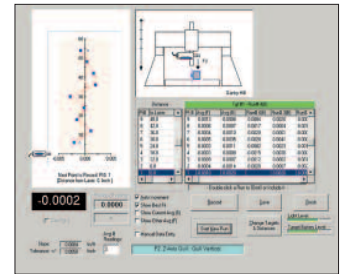

**Machine Tool Geometry — Data Taking Screen.**  
Records up to 10 bi-directional runs for each axis.

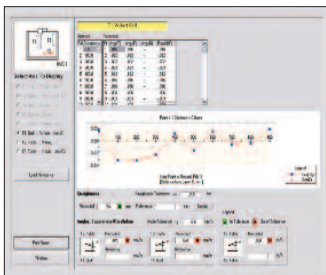

**Machine Tool Geometry — Graph Screen.**  
Shows axis TIRs, parallelism and squareness between axes.

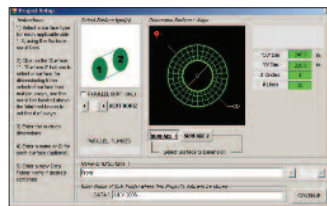

**Plane5 — Projects Setup Screen.**  
Configure shape and number of points for up to 7 surfaces. Used for measuring flatness, squareness and parallelism of machined surfaces.

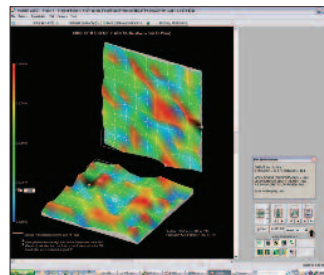

**Plane5 — Plot View Screen.**  
3-D plot of surface flatness of 3 or more surfaces.

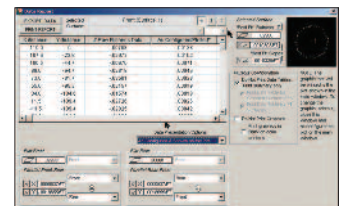

**Plane5 — Report Screen.**  
Complete report showing flatness, squareness and parallelism of all surfaces measured.

## Accessories



**A-910-2.4ZB USB 2.4GHz Radio Receiver** for tablets and laptops.



**R-1355-2.4ZB Rugged PDA Readout** with Read9 Software and 2.4GHz Wireless communication displays up to 10 targets.



**A-1519/A-1520 Universal Targets** 2.4GHz Wireless data transmission with 2 resolution options and large measuring range.



**L-106 Instrument Stand** Lightweight, variable-height stands for flexible setup.

# A Hamar Laser System For Every Alignment Need

## Applications



### Machine Tool

- Floor and Spar Mills
- Gantries
- Horizontal and Vertical Boring Mills
- Horizontal and Vertical Machining Centers
- Large-Lathe Beds
- Machine Tool Assembly and Calibration
- Roll-Forming Machines
- Transfer-Line Wing Bases
- Vertical and Horizontal Presses
- Vertical-Turning Lathes

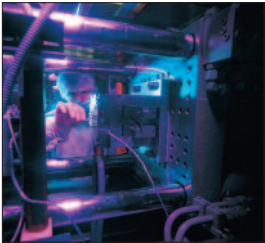

### Plastics

- Blown-Film Lines
- Film Lines
- Injection Molding Machines



### Leveling

- Machine Bed Leveling
- Split Joints On Steam Turbines

### Roll Alignment

- Aluminum Mills
- Continuous Casting Machines
- Paper Mills
- Printing Presses
- Steel Mills
- Textile Mills



### Quality Control

- Calibration of Large Fixtures
- Checking Flatness when
- Large-Part Flatness, Straightness
- Surface Plate Calibration and Jigs and Squareness Checks
- Scraping Machine Rails

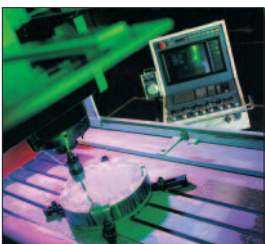

### Fabricating Machinery

- Laser-Cutting Machines
- Routers
- Saw Mills
- Tube-Bending Machines
- Water-Jet Machines
- Woodworking Machines



### Fabrication Alignment

- Agricultural Machinery Assembly
- Large Construction Machinery Assembly
- Locomotive Assembly
- Truck Bed Assembly
- Wind Turbine Flange Parallelism



### Aerospace

- Aircraft Interior Alignment (Storage Bins, Gallies, etc.)
- Body-to-Body Join Assembly
- Floor Beam Alignment
- Jig/Tooling Calibration and Leveling
- Seat-Track Alignment
- Wing-to-Body Joining Alignment



### Ship Building

- Elevator Shaft Alignment
- Gun-Bearing Alignment
- LNG Tanker Hull Construction
- Section Alignment and Layout



# Specifications

|                              |  |
|------------------------------|--|
| Weight                       | Laser: 3 lbs. (1.3 kg)<br>Base: 4.8 lbs. (2.2 kg)<br>Battery Pack: 1 lb. (0.45 kg)   |
| Material                     | Laser: Aluminum and stainless steel<br>Base: Aluminum  |
| Laser Type                   | Class II visible diode, 635 nM wavelength<br>(class I in Scanning Mode);<br>0.160" (4.06 mm) beam diameter   |
| Beam Power                   | 0.9 mW per straight beam   |
| Beam Stability               | .0001"/hr/°F (0.005 mm/hr/°C) translational<br>0.2 arc sec./hr/°F (0.36 arc sec/hr/°C) angular   |
| Beam Straightness            | .00001 in/ft (0.0008 mm/M)   |
| Laser Plane Flatness         | <b>For L-730 Series:</b> <ul style="list-style-type: none"> <li>• 180/360° Sweep: 2.0 arc sec (0.00012 in/ft or 0.01 mm/M), plus translational error of +/- 0.0003" (0.008 mm)</li> <li>• 90° Sweep: 1 arc sec (.00006 in/ft or 0.005 mm/M), plus translational error of +/- .00015" (0.004 mm).</li> </ul> <b>For L-740 Series:</b> <ul style="list-style-type: none"> <li>• 180/360° Sweep: 0.5 arc sec (0.00003 in/ft or 0.0025 mm/M), plus translational error of +/- 0.0001" (0.0025 mm)</li> <li>• 90° Sweep: 0.25 arc sec (.000015 in/ft or 0.0013 mm/M) plus translational error of +/- .00005" (0.00013 mm).</li> </ul> |
| Beam/Plane                   | <b>For L-740 Series:</b> <ul style="list-style-type: none"> <li>i) Top to Left and Top to Back Plane squareness 1 arc sec (0.00006 in/ft or 0.005 mm/M);</li> <li>ii) Left to Back Plane squareness 3 arc secs (0.00018 in/ft or 0.015 mm/M);</li> </ul> <b>For L-730 Series:</b> <ul style="list-style-type: none"> <li>i) Top to Left and Top to Back Plane squareness 2 arc secs (0.00012 in/ft or 0.01 mm/M);</li> <li>ii) Left to Back Plane squareness 3 arc secs (0.00018 in/ft or 0.015 mm/M);</li> </ul>  |
| Operating Range              | 100 feet (30.5 meters) in radius   |
| Operating Modes              | 1, 2, or 3 beams and/or 1, 2, or 3 continuously rotating laser planes in any combination, individually switched  |
| Power Supply                 | 9V DC external battery pack (4 cells) or 115V AC adapter   |
| Power Draw                   | (See chart)  |
| Coarse Adjustment Range      | +/- 3 degrees  |
| Coarse Adjustment Resolution | .010" (0.25 mm) in 100 feet (30.5 meters)  |
| Fine Adjustment Range        | +/- 0.3 degrees (L-740 Series Only)  |
| Fine Adjustment Resolution   | .001" (0.025 mm) in 100 feet (30.5 meters) (L-740 Series Only)   |

## L-740 Series Ultra-Precision Machine Tool Alignment System\*

top view

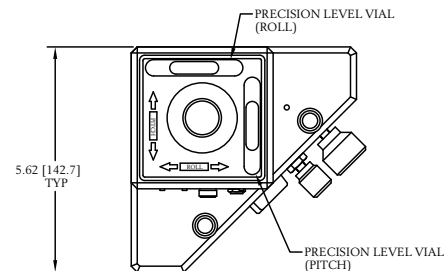

side view

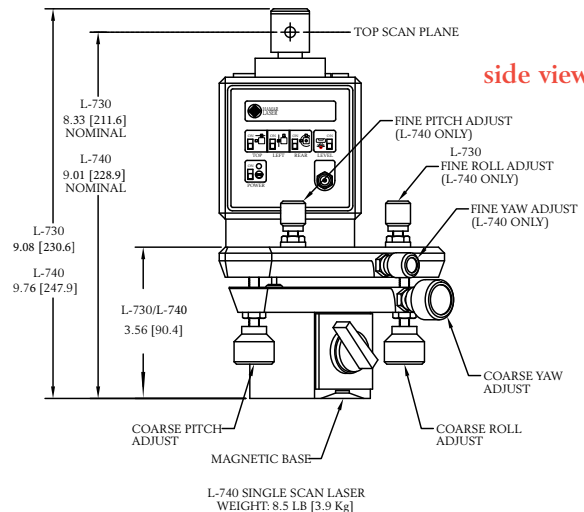

L-740 SINGLE SCAN LASER  
WEIGHT: 8.5 LB [3.9 Kg]

All dimensions in inches [mm]

\* See [www.hamarlaser.com](http://www.hamarlaser.com) for a drawing of the L-733 Triple Scan Laser.

| Power Draw | Laser Only | Laser & Scanner | Battery Life* |
|------------|------------|-----------------|---------------|
| 1 Beam     | 100 mA     | 130 mA          | 2.5 hrs.      |
| 2 Beams    | 180 mA     | 230 mA          | 1.4 hrs.      |
| 3 Beams    | 260 mA     | 330 mA          | 1.0 hrs.      |

\* Per 9V alkaline battery (500 mA hrs.). Multiply battery life figure by the number of batteries used (external battery pack uses 4 cells).



**HAMAR LASER**<sup>®</sup>

ALIGN WITH THE BEST



Hamar Laser Instruments, Inc.  
5 Ye Olde Road, Danbury, CT 06810  
Phone: +1.203.730.4600 • 800.826.6185  
Fax: +1.203.730.4611  
E-mail: [sales@hamarlaser.com](mailto:sales@hamarlaser.com)  
[www.hamarlaser.com](http://www.hamarlaser.com)